

16. Electric Power Steering System

A: WIRING DIAGRAM

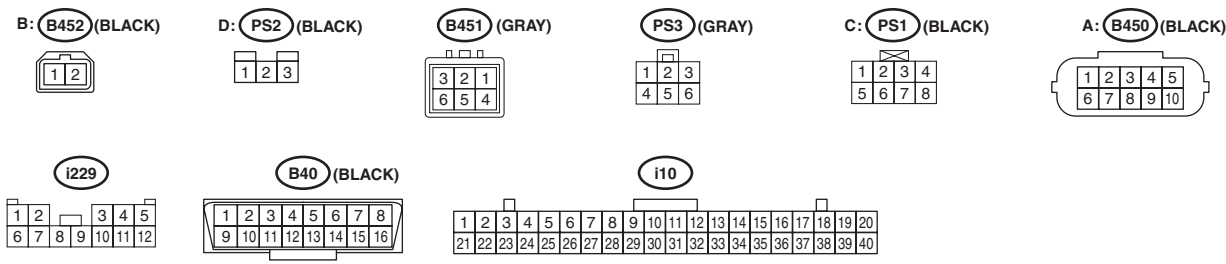
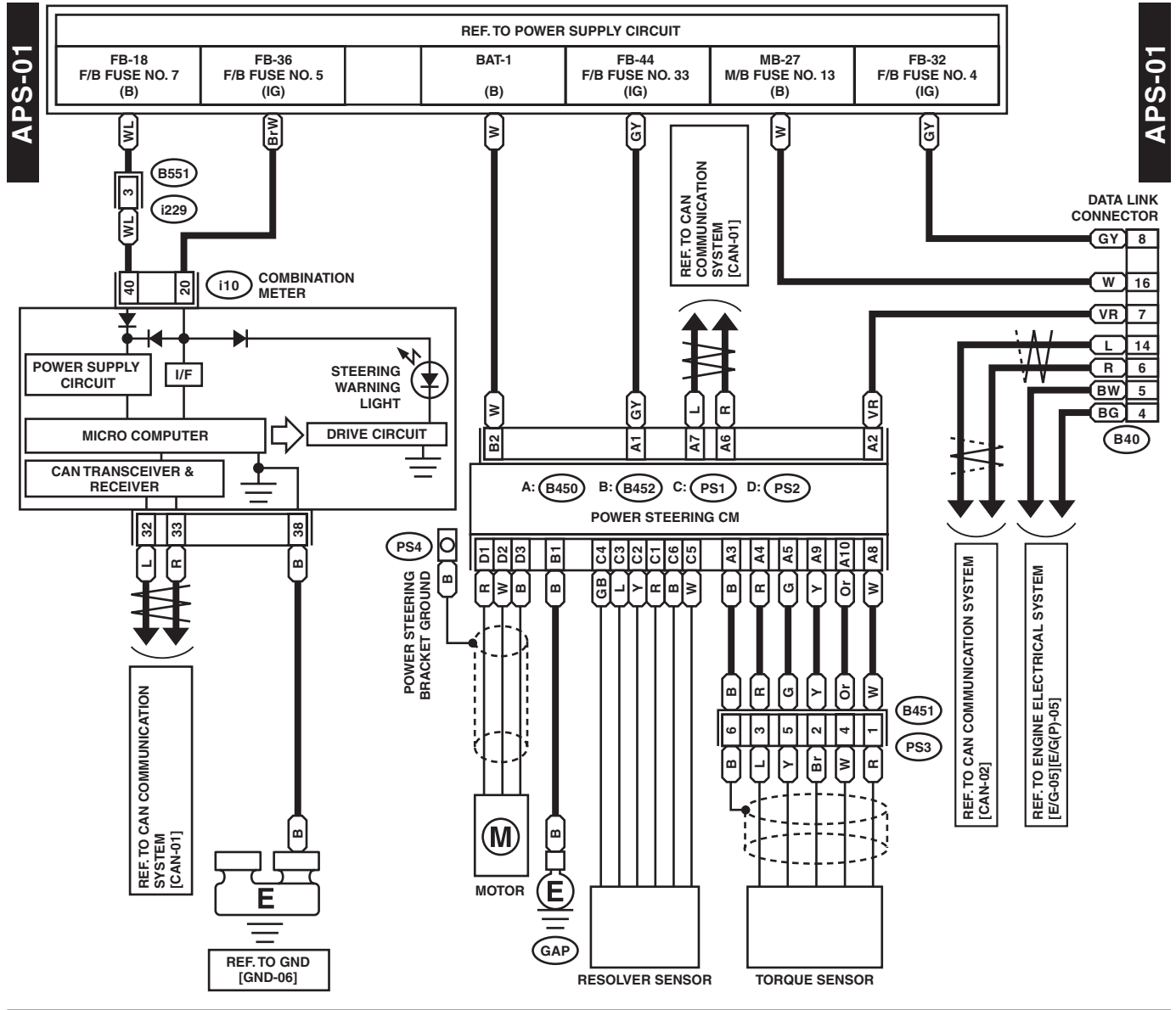

WI-48218